



**TENKA**<sup>®</sup>  
solar **GROUP GmbH**

## Orion series III 430-455 Watt

### KEY FEATURES



Our solar cells offer high conversion efficiency to ensure the highest quality

Our high performing modules

The modules can withstand high wind-pressure, snow loads and extreme temperatures

Passed IEC 5400 Pa mechanical loading test

### QUALITY & SAFETY

Industry leading power output warranty

(15 years/90%, 30 years/80%)

25-year warranty on materials & workmanship

Fire Rating: Class 1

#### Premium Performance Warranty

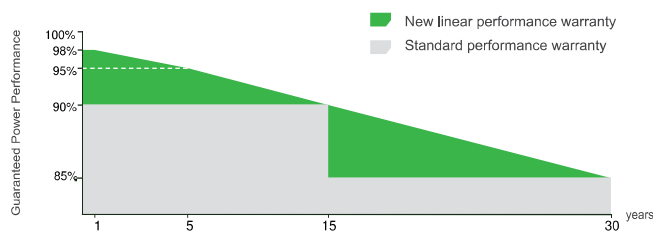

ISO9001:2008, ISO14001:2004, OHSAS18001 certified factory

IEC61215, IEC61730 certified products

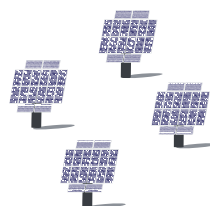

Solar power plants

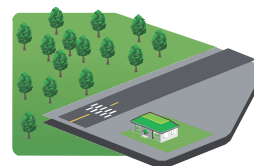

Off-grid systems

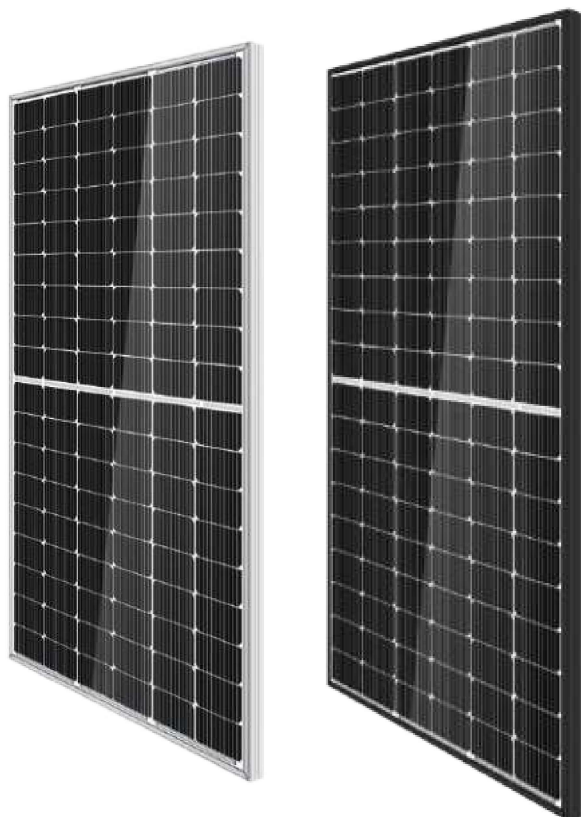

### APPLICATIONS



On-grid residential roof-tops



On-grid commercial/  
industrial roof-tops



## Engineering Drawings

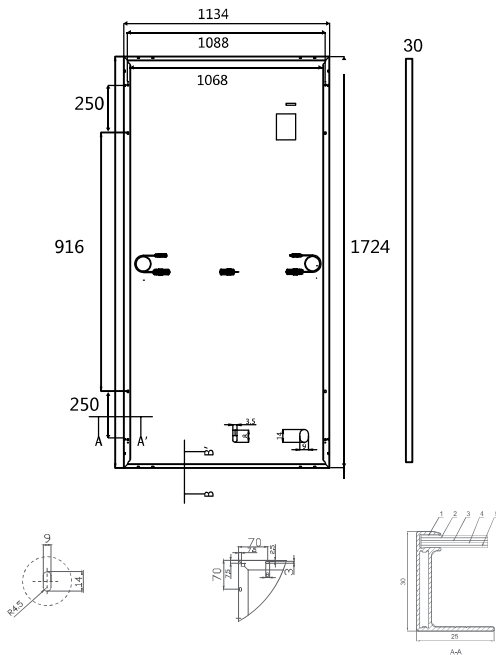

## Packaging Configuration

Standard packaging	72PCS/PALLET
Module quantity per 20' container	432PCS
Module quantity per 40' container	936PCS

## Electrical Performance & Temperature Dependence

### Current-Voltage & Power-Voltage Curves at Different Irradiances

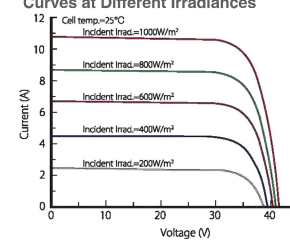

### Current-Voltage Curves at Different Temperatures

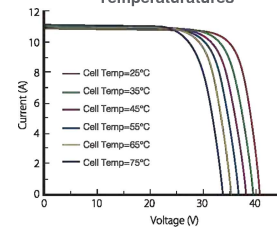

## Mechanical Characteristics

Cell Type	Perc Mono-crystalline 182mm
No. of cells	108
Dimensions	1724×1134×30mm
Weight	20.0kg
Front Glass	Orion Technology, Low Iron, AR Coating Glass
Frame	Anodized Aluminium Alloy
Junction Box	IP68 Rated
Output Cables	TUV 1×4.0mm / UL 12A-WG, Length:1100mm

## SPECIFICATIONS

Module Type	TKA430M-108	TKA435M-108	TKA440M-108	TKA445M-108	TKA450M-108	TKA455M-108
Maximum Power at STC(Pmax)	430Wp	435Wp	440Wp	445Wp	450Wp	455Wp
Maximum Power Voltage (Vmp)	32.72V	32.96V	33.20V	33.44V	33.66V	33.90V
Maximum Power Current (Imp)	13.15A	13.21A	13.27A	13.33A	13.39A	13.45A
Open-circuit Voltage (Voc)	38.62V	38.86V	39.00V	39.14V	39.28V	39.42V
Short-circuit Current (Isc)	13.90A	13.96A	14.02A	14.08A	14.14A	14.20A
Module Efficiency(%)	21.99%	22.25%	22.51%	22.76%	23.02%	23.27%
Operating Temperature(°C)	-40°C~+85°C					
Maximum system voltage	1500V DC					
Maximum series fuse rating	20A					
Power tolerance	±5%					
Temperature coefficients of Pmax	-0.43%/°C					
Temperature coefficients of Voc	-0.30%/°C					
Temperature coefficients of Isc	0.04%/°C					
Nominal operating cell temperature (NOCT)	45±2°C					

STC: Irradiance 1000W/m<sup>2</sup> Module Temperature 25°C AM=1.5

\* Power measurement tolerance: + 5%

**TENKA**<sup>®</sup>  
solar **GROUP** GmbH